

ekinex

CONTROL YOUR LIVING SPACE

Universal interface (4 IN conf. / 2 OUT relé 5 A)

Code: EK-CE2-TP



Datasheet STEKCE2TP_EN

KNX bus device for connecting potential-free contacts devices as inputs (one of which configurable as passive NTC temperature sensors or thermostat function) and 2-channels outputs with 5 A bistable relays. It has to be used in KNX installations for control of homes and buildings.



Description

The ekinex® universal interface is a KNX S-mode device that can be used as input or output. The device includes:

- 4-channels input to connect to the bus devices with free-potential contacts; one of them can be configured as NTC passive temperature sensor, along with specific thermostat function;
- 2-channels output with 5 A latching relays.

The device is provided with an integrated bus communication module and is realized in a compact design for installation in flush-mounting wall boxes. It is powered by the KNX bus line with a SELV voltage 30 Vdc and does not require auxiliary power.

The scanning voltage for the input channels is produced by the device.

Functionalities

Each input channel of this device can be programmed as [DI], in order to manage the following functionalities:

- on/off switching of single loads or group of loads;
- detecting the state of signaling contacts (from safety devices, alarms, etc.);
- recalling and saving of scenes;
- sending values on the bus (temperature, brightness, etc.);
- switching to forced operating mode (lock);

- counting of impulses and switching cycles;
- save / recall functions for scenes and sequences.

The first input channel can be programmed to carry out the following functions alternatively:

- Temperature sensor for values sending;
- on/off type thermostat, to manage control valves for heating/cooling systems or fan coil.

Each output channel of the device can be programmed as [DO] for:

- single: delay for on and off switching, staircase lighting function, scene and sequence management, lock and logic functions;
- coupled: roller shutters or venetian blinds control.

Main characteristics

- Housing in plastic material
- Wall installation in flush mounting box or, with a mounting support, on 35 mm rail (according to EN 60715)
- Protection degree IP20 (installed device)
- Classification climatic 3K5 and mechanical 3M2 (according to EN 50491-2)
- Pollution degree 2 (according to IEC 60664-1)
- Weight 20 g
- Dimensions 43 x 43 x 22.5 mm (WxHxD)

Technical data

- Power supply 30 Vdc from KNX bus line
- Current consumption < 10 mA
- Rated load current: 5A max for resistive load ($\cos\phi = 1$), 2A max for inductive load ($\cos\phi = 0,4$)

Environmental conditions

- Operating temperature: - 5 ... + 45°C
- Storage temperature: - 25 ... + 55°C
- Transport temperature: - 25 ... + 70°C
- Relative humidity: 95% not condensing

Accessories

Rail-mounting support

The device can be mounted on 35 mm rail (according to EN 60715) with the support EK-SMG-35 to be ordered separately.

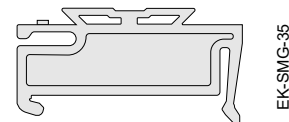

Spring for hooking on wall-mounting devices

The device can be hooked on the back of some ekinex® wall-mounting devices with the spring EK-MAR to be ordered separately (preventively check the compatibility).

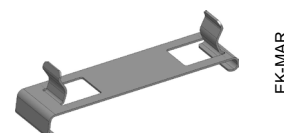

Switching, display and connection elements

The device is equipped with a programming LED and a programming pushbutton, a terminal block for connection of the KNX bus line and screw terminal blocks for connection of inputs and outputs.

Switching and display elements

- pushbutton (3) for switching between the normal and programming operating modes
- red LED (2) for indication of the active operating mode (on = programming, off = normal operation)

Connection elements

- KNX bus terminal block (1)
- 6-pole (4) and 3-pole (5) screw terminals for connection of inputs and outputs

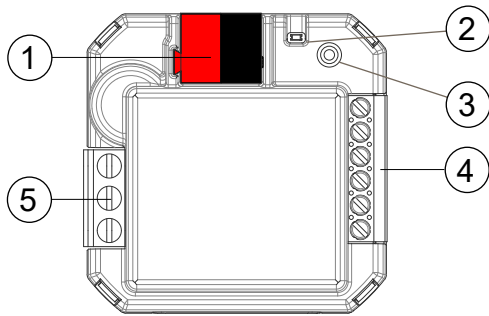

- 1) Terminal block for KNX bus line
- 2) Programming LED
- 3) Programming pushbutton
- 4) 6-pole terminal block
- 5) 3-pole terminal block

Connection of the KNX bus line

The connection of the bus line is made with the KNX terminal block (1) included in delivery and inserted into the slot of the housing.

Characteristics of the KNX terminal block

- spring clamping of conductors
- 4 seats for conductors for each polarity
- terminal suitable for KNX bus cable with single-wire conductors and diameter between 0.6 and 0.8 mm
- recommended wire stripping approx. 5 mm
- color codification: red = + (positive) bus conductor, black = - (negative) bus conductor

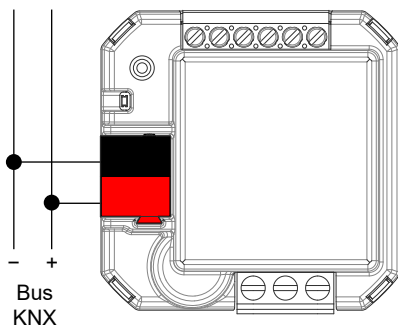

Warning! In order to supply the KNX bus lines use only KNX bus power supplies (e.g. ekinex EK-AB1-TP or EK-AG1-TP). The use of other power supplies can compromise the communication and damage the devices connected to the bus.

Connection of inputs

Inputs are connected by means of the 6-poles screw terminal block (4), inserted into the proper slot on the upper side of the housing.

Characteristics of the terminals

- screw clamping of conductors
- wiring: 30-14 AWG / 0.05-2.08 mm² (solid or stranded)
- stripping recommended approx: 6.0 mm
- max torque 0.5 Nm

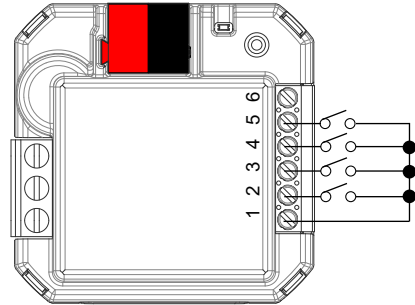

Connection of free-potential contacts

Block	Mark	Connection
1, 6	COM	Input common
2	IN1	Input 1 - configurable
3	IN2	Input 2
4	IN3	Input 3
5	IN4	Input 4

In case of input connections longer than 1 m, shielded cables must be used. In any case, do not exceed 5 m in length.



Warning! If configured as analogic, to an input channel it is allowed exclusively the connection of a NTC temperature sensor with a characteristic resistance value of 10 kΩ at 25°C, β = 3435.

Connection of outputs

Outputs are connected by means of the screw terminal blocks (5), inserted into the specific slots on the lower side of the housing.

Characteristics of the terminals

- screw clamping of conductors
- maximum cross section of conductor 1 mm²
- recommended wire stripping approx. 5 mm
- torque max 0.2 Nm

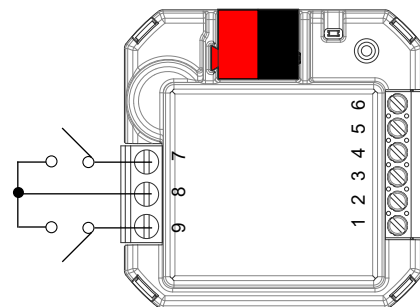

Connection loads to be controlled (relais 5 A)

Block	Mark	Connection
7	OUT1	Output Relais 1
8	COM	Output common
9	OUT2	Output Relais 2



Warning! The electrical connection of the device can be carried out only by qualified personnel. The incorrect installation may result in electric shock or fire. Before making the electrical connections, make sure the power supply has been turned off.

Mounting

The device has degree of protection IP20, and is therefore suitable for use in dry interior rooms. The support EK-SMG-35 allows the mounting on 35 mm rail in boards or cabinets for electrical distribution.

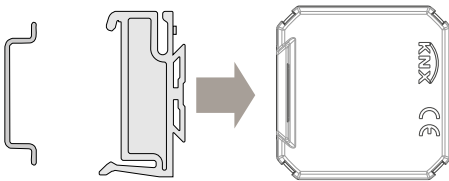

a) Insert the mounting support into the appropriate shaped profile of the interface

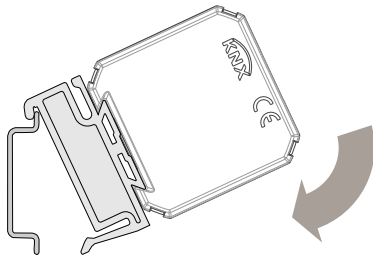

b) Place the support clamping tooth on the top edge of the mounting rail and rotate device and support towards the guide until it completely engages

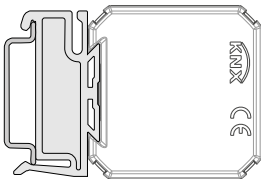

c) Once fastened, connect the bus line, the inputs and the outputs

Configuration and commissioning

Configuration and commissioning of the device require the use of the ETS® (Engineering Tool Software) program V4 2.0 or later releases. These activities must be carried out according to the design of the building automation system done by a qualified planner.

Configuration

For the configuration of the device parameters the corresponding application program or the whole ekinex® product database must be loaded in the ETS program. For detailed information on configuration options, refer to the application manual of the device available on the website www.ekinex.com.

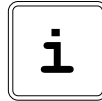

Note. The configuration and commissioning of KNX devices require specialized skills. To acquire these skills, you should attend the workshops at KNX certified training centers.

Product code	Application software (## = release)	Comm. objects (max nr.)	Group addresses (max nr.)
EK-CE2-TP	APEKCE2TP##.knxprod	196	196

Commissioning

For commissioning the device the following activities are required:

- make the electrical connections as described above;
- turn on the bus power supply;
- switch the device operation to the programming mode by pressing the programming pushbutton located on the front side of the housing. In this mode of operation, the programming LED is turned on;
- download into the device the physical address and the configuration with the ETS® program.

At the end of the download the operation of the device automatically returns to normal mode; in this mode the programming LED is turned off. Now the bus device is programmed and ready for use.

Reset of the device

To reset the device remove the bus connection by extracting the bus terminal from its seat. Keeping pressed the programming pushbutton, reinsert the bus terminal in his seat; the programming LED blinks fast. Release the programming button and remove the bus terminal again; the reset was carried out. Now you need to address and configure again the device via ETS.



Warning! The reset restores the device back to the state of delivery from the factory. The address and the value of the parameters set during configuration will be lost.

Dimensions

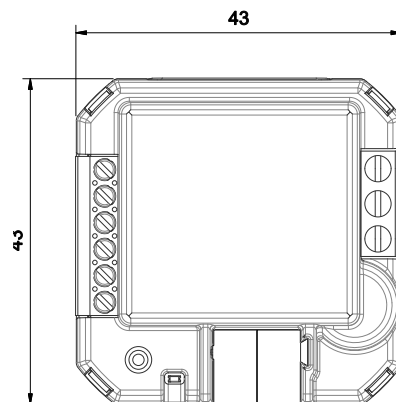

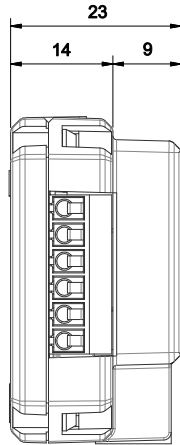

Marks

- KNX
- CE: the device complies with the Electromagnetic Compatibility Directive (2014/30/EU). Tests carried out according to EN IEC 63044-5-1:2019 and EN IEC 63044-5-2:2019.

Maintenance

The device is maintenance-free. To clean use a dry cloth. It must be avoided the use of solvents or other aggressive substances.

Disposal



At the end of its useful life the product described in this datasheet is classified as waste from electronic equipment in accordance with the European Directive 2012/19/EU (WEEE recast), and cannot be disposed together with the municipal undifferentiated solid waste.



Warning! Incorrect disposal of this product may cause serious damage to the environment and human health. Please be informed about the correct disposal procedures for waste collecting and processing provided by local authorities.

Documentation

This datasheet refers to the release A2.0 of the ekinex® EK-CE2-TP universal interface and is available for download at www.ekinex.com as a PDF (Portable Data Format) file.

File name	Device release	Updating
STEKCE2TP_EN.pdf	A2.0	03 / 2024

Warnings

- Installation, electrical connection, configuration and commissioning of the device can only be carried out by qualified personnel in compliance with the applicable technical standards and laws of the respective countries
- Opening the housing of the device causes the immediate end of the warranty period
- In case of tampering, the compliance with the essential requirements of the applicable directives, for which the device has been certified, is no longer guaranteed
- ekinex® KNX defective devices must be returned to the manufacturer at the following address: EKINEX S.p.A. Via Novara 37, I-28010 Vaprio d'Agogna (NO) Italy

Other information

- The instruction sheet must be delivered to the end customer with the project documentation
- For further information on the product, please contact the ekinex® technical support at the e-mail address: support@ekinex.com or visit the website www.ekinex.com
- Each ekinex® device has a unique serial number on the label. The serial number can be used by installers or system integrators for documentation purposes and has to be added in each communication addressed to the EKINEX technical support in case of malfunctioning of the device
- KNX® ed ETS® are registered trademarks of KNX Association cvba, Brussels

© EKINEX S.p.A. The company reserves the right to make changes to this documentation without notice.