

Thermal Drive Actuator N 605D41, 6 x AC 24...230 V

N 605D41



The thermal drive actuators are used for controlling electro-thermal actuators for heating or cooling systems.

- 6 semiconductor outputs for noiseless control of AC 24 V or AC 230 V actuators
- Direct operation for efficient installation with switching status and control value display via LED.
- Error LEDs on the device front for indicating a mains voltage failure and overload/short circuit faults
- Maintenance-free terminals for connecting and looping through solid, stranded and fine-stranded conductors.

Functions for configuration with ETS:

- With priority control of security and override functions
- Automatic or demand-based or manual valve flushing
- Extensive, internal room temperature controllers and ventilation controllers (which can be assigned freely or for each channel)
- Powerful calculator modules for weighting temperature values or determining the largest or a weighted control value
- Interaction with primary systems for heating demand or cooling demand requirements and demand-based pump control.

Characteristics

The thermal drive actuator is used to control electro-thermal actuators in water-based heating or cooling systems. It is used in building automation. Device control is conducted via KNX.

The thermal drive actuator features semiconductor outputs. These can be used to silently control several AC 230 V or AC 24 V actuators per channel or channel group according to their power consumption.

The actuator controls both de-energized closed and de-energized open actuators.

In addition, the thermal drive actuator contains internal room temperature controllers matching the number of valve outputs. These can be internally assigned directly to the valve outputs. The various control values of the controller are directly linked to the control value inputs of the valve outputs without external bus communication. In the same way, the valve outputs can receive their control values via communication objects from external room temperature controllers, such as those integrated into sensors or room control units. On the other hand, these room temperature controllers can be used as separate function blocks. In this case, the various control values are linked via communication objects to external thermal drive actuators, motor actuators or fan coil actuators that do not include a controller function.

The thermal drive actuator has a direct operating level at the front of the device. A membrane keypad with one operating key and one status LED per channel can be used to open or close the control valves or display the valve positions/control values.

The thermal drive actuator detects a failure of the valve supply voltage and indicates the failure via simultaneous flashing (1 Hz) of all error LEDs on the front of the device. This failure is also sent via the bus.

The thermal drive actuator also detects and overload or short circuit on the valve outputs. To do this, a diagnostic routine is executed. If a group of channel outputs exceeds a total current, the affected error LEDs of that group light up on the front panel of the device. This overload is also sent via the bus. In the event of an overload/short-circuit fault on an individual channel output, the affected fault LED on the front panel flashes (10 Hz), while the overload/short-circuit fault is signaled to the respective channel via the bus at the same time.

The device is a rail-mounted device in N dimension for installation in distributions and installation on 35-mm DIN rails as per standard IEC 60715. The bus connection of the device uses a bus terminal block. The electronics of the device are supplied via the bus voltage (no additional supply voltage required). The maintenance-free terminals are for connecting solid and fine-stranded conductors with conductor cross-sections from 0.5 to 2.5 mm² or for connecting multi-stranded conductors with 2.5 mm² conductor cross-sections to the output channels. Stranded and fine-stranded conductors can be plugged into the terminals without ferrules.

The thermal drive actuator N 605D41 consists of the device (hardware) and the application program (software).

Functions

Factory settings

In the factory settings, the functions control value transfer for a "switching control value (1 bit)" and a "continuous control value (8 bit)" are assigned to the building site function for all channels (outputs). Direct operation is enabled.

Building site function

In the factory settings, the building site function enables transfer for a "switching control value (1 bit)" and a "continuous control value (8 bit)" for controlling the thermal actuators via a corresponding bus pushbutton, even if these devices are yet to be commissioned via the Engineering Tool Software (ETS).

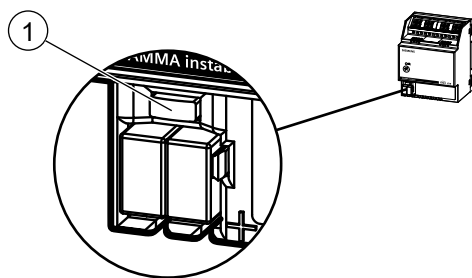

Fig. 1: Programming button and programming LED (exemplary illustration)



After bus voltage recovery, wait several seconds before pushing the programming (1) button (not before booting is complete).

Activate programming mode

- a) Briefly press the programming button (1) (< 2 seconds).
 - ⇒ Programming mode is activated.
 - ⇒ The programming LED (1) illuminates continuously.

Deactivating programming mode

- ✓ Programming mode is activated. The programming LED (1) illuminates continuously.
- a) Briefly press the programming button (1) (< 2 seconds).
 - ⇒ Programming mode is deactivated.
 - ⇒ The programming LED (1) is not illuminated.

Resetting the device to factory settings

NOTICE



Loss of data due to resetting device!

When you reset the device, all parameters and settings entered are deleted.

- Ensure that the device is really supposed to be reset.

A very long push of the programming button (1) of more than 20 seconds resets the device to its factory settings. This is indicated by a uniform flashing of the programming LED for a duration of 8 seconds.

All configuration settings are deleted. The building site function from the factory settings is re-activated.

Behavior on unloading the application program

After unloading the application program with the ETS, the unloaded device has no functions.

Behavior on voltage failure/recovery

The electronics of the device are bus powered. A mains voltage failure therefore only leads to a functional failure of the device if the bus voltage also fails as a result of the mains voltage failure.

In case of bus voltage failure, the current status and other values for each channel are saved permanently so that they can be restored when the bus voltage is recovered.

When bus voltage is recovered, the configured actions for each channel are executed and, depending on the parameters set, new statuses are reported.

For each active override, a starting behavior on bus voltage recovery can be configured (Off, On, Deactivated, Last value).

Setting the valve control direction

De-energized closed or de-energized open thermal actuators can be connected to the thermal drive actuator. The valve control direction is set to take this behavior into account in the further electrical valve control.

Controlling the actuator channels

The actuator channels are controlled via switching commands On/Off (1-bit); the telegrams are converted directly at the output. Continuous positioning commands in percent (1 byte) are converted into a switching control of the thermal actuators via pulse width modulation (PWM) or via limit value evaluation (limit values for opening or closing the valve).

Control value monitoring

Schutzenteilung If positioning commands do not occur within a configurable time, emergency operation with configurable default behavior is activated and an error status is sent. Different continuous default control values (%) in normal operation can be set for summer and winter mode.

Control value limitation for continuous control value (1 byte)

The control value can be limited to maximum and minimum values (%) e.g. for basic temperature control or to increase the service life of the thermal drives.

On the other hand, the valve can always be closed if the control value is smaller than a configurable limit value or the valve can always be opened if the control value is larger than a configurable limit value. Specific valve characteristics are thus taken into account.

Direct operation

The membrane keypad on the device front can be used to operate the actuators directly. A status LED for each channel shows the status of the valve.

Direct operation enables the installer to test the installation and thermal actuators prior to configuration with ETS. For each channel, a button can be used to open and close the valve. The status LED shows if the valve is open or closed. The configured valve control direction is taken into account here.

Mains voltage failure detection

The failure of the valve voltage supply is signaled directly by the simultaneous flashing (1 Hz) of all 6 error LEDs on the front of the device. A 1-bit message can be sent at the same time.

Overload and short circuit detection

A diagnostic routine is performed to identify the overload. The diagnostic routine can also be started manually on the relevant channel group A/B/C or D/E/F by means of a long push of a button (> 5 s). Alternatively, a diagnostic run by group can be started via a 1-bit command for each group. In the diagnostic routine, the affected error LEDs of channel groups A/B/C and/or D/E/F on the front of the device flash for approx. 60 s (3 Hz). At the same time, the execution of a diagnostic routine related to channels A/B/C and/or D/E/F can be sent as a 1-bit message.

Group-related evaluation of channels A/B/C or D/E/F

If the total current exceeds $\sum I > I_{\max}$ per group, all error LEDs of the affected channel groups A/B/C or D/E/F light up on the front of the device. At the same time, the overload can be sent as a 1-bit message in groups for channels A/B/C or D/E/F.

Excess current/short circuit evaluation per channel

In the event of an excess current/short circuit fault ($I > I_{\max}$) on a single channel, the respective channel LED A, B, C, D, E or F flashes (10 Hz) on the front of the device. At the same time, the respective overload for the affected channel can be sent as a 1-bit message.

Valve flushing

Valve flushing is used to protect against calcification and seizure of valves that are not used for an extended period of time

Manual valve flushing

Start (for the set duration)/stop via a 1-bit object

Automatic valve flushing

Cyclically in weeks or demand-oriented if the control value remains below a limit value. Valve flushing is reactivated at a control value of 0%.

Counting of operating hours

An operating hours counter can record the operating hours in hours or seconds at the valve output using various evaluation methods.

On the one hand, the switch-on processes can be counted when electrical voltage is present at the output, or the time for heating or cooling can be recorded, i.e. when the control value exceeds an adjustable threshold value. When an adjustable threshold value is exceeded, a message is sent via the bus.

Counting of switching cycles

Counting of switching cycles records the switching operations on the valve output. If an adjustable threshold value is exceeded, a message is sent via the bus.

Overrides

The thermal drive actuator offers up to 6 override blocks per channel for specific applications. These can be used to configure settings for lock function, forced control, forced position, service mode and user-defined settings. Their effectiveness can be individually set according to priorities.

Room temperature control

The thermal drive actuator contains up to 6 internal room temperature controllers as appropriate for the number of valve outputs. These can be used externally or internally assigned directly to the valve outputs. The various control values of the controller are transferred directly to the control value inputs of the valve outputs without external bus communication. Only a single KNX bus device is used for valve control for single room temperature control.

In addition, the room temperature controllers can be used as separate, independent function blocks in a KNX system. In this case, the various control values are linked via communication objects to external thermal drive actuators, motor actuators or fan coil actuators that do not include a controller function.

Heating or cooling requirements

The heating or cooling requirements are used as a power saving function for a primary system. For heating and cooling demand requirements, the assigned control values of the valve outputs are evaluated. Based on the result, relevant switching inputs to burner and boiler controls are switched according to demand via a KNX switching actuator.

Determination of the largest or a weighted control value

The largest or a weighted control value is determined via the internal calculator. The result can be sent as a 1-byte control value directly to a primary system with integrated KNX interface. The flow temperature can thus be adapted to the demand from the rooms.

Pump control

The pump control is used for demand-based control of circulating pumps as a power saving function of a primary system. In the thermal drive actuator, there are two controls for circulating pumps with which a heating cycle and a cooling cycle can be controlled separately. In doing so, the assigned control values of the valve outputs are evaluated. Based on the result of the evaluation of the control values, the pumps can be switched based on demand via a KNX switching actuator. In addition, separate fixed position protection prevents the pumps from jamming if they have not been switched on for a longer period of time.

Logic operations

The thermal drive actuator has 6 independent logic blocks with which different mathematical operations are possible: AND, OR, XOR, TRIGGER, LOCK.

The inputs can be linked internally in the device with the status output of the valve control values of a channel or with any KNX communication objects, including external devices. The logic result is sent via a KNX communication object. The data types of the logic inputs and outputs can be selected freely.

Display/operating elements and error displays on the device.

On the front of the thermal drive actuator, the error LEDs indicate whether there is an error on the device and what type of error it is. The buttons can be used to start the diagnostic routine.

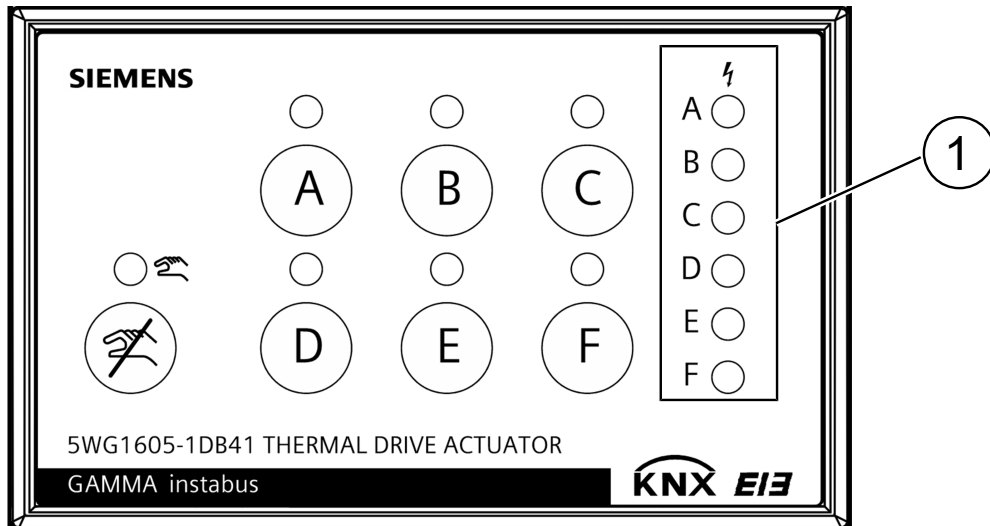

Fig. 2: Error display on the device

1 Error LEDs: Error display of the channels and channel groups

Error messages

Mains voltage failure

The thermal drive actuator detects a failure of the common valve voltage supply. The failure is indicated via the error LEDs on the front of the device.

The failure of the valve voltage supply can be reported via the bus.

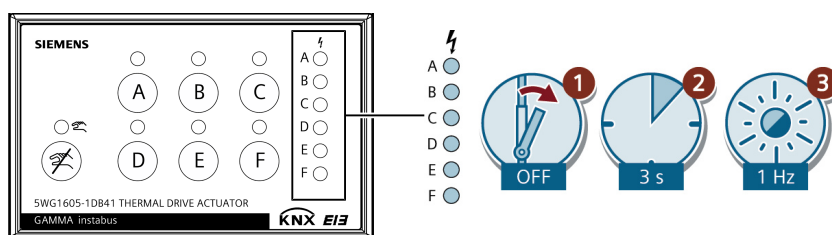

Fig. 3: Error display on mains voltage failure

Description

- Failure of the AC 24 V or AC 230 V valve supply voltage.
- All 6 error LEDs flash simultaneously with a frequency of 1 Hz.
- The failure of the mains voltage is also reported via a 1-bit error message via the KNX bus.

Diagnostic routine

Each channel or a channel group of the thermal drive actuator detects an overload or a short circuit on the valve outputs. Here, a diagnostic routine is executed, which works group by group for the channel outputs A/B/C or D/E/F and takes approx. 60 s.

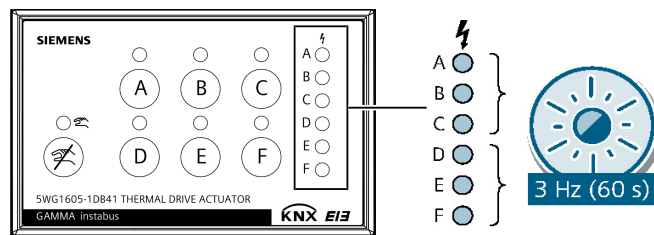

Fig. 4: Display of the diagnostic routine

Description

- The affected error LEDs of channel groups A/B/C and/or D/E/F flash at a frequency of 3 Hz for approx. 60 s.
- The diagnostic routine starts after an overload has been detected.

There are three different ways in which a diagnostic routine can be started:

- Automatic start when a fault is detected (overload).
- Manual start using a long push of a button (> 5 s) on channel A, B or C to start the diagnostic routine for channel group A/B/C or on channel D, E or F to start the diagnostic routine for channel group D/E/F (Fig.: “Error display on the device,” 2).
- When sending a start telegram via the communication object (“Start diagnostic run channels A/B/C” or “Start diagnostic run channels D/E/F”).

Short circuit/overload per channel

NOTICE



Damage to the device due to improper operation in the event of a permanent short circuit on the channel or a channel group

The device can be damaged if the diagnostic routine is started repeatedly (via a telegram or via the channel key) when a short circuit is permanently present.

- Before starting the diagnostic routine, the short circuit fault must be resolved.

In the event of an overload/short-circuit fault on a single channel output, the affected fault LED on the front of the device flashes at a frequency of 10 Hz (fig. “Error display on the device,” 1).

The overload/short circuit error for the respective channel can be reported via the bus.

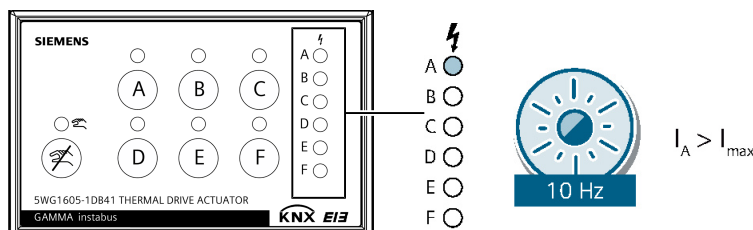

Fig. 5: Error display for short circuit/overload per channel

Description

- The error LED of the affected channel flashes with a frequency of 10 Hz (example channel A).

Overload on the channel groups

In the event of a total current overflow of a group of channel outputs, the error LEDs of the affected channel group on the front of the device light up continuously (fig. "Error display on the device," 1).

The overload can be reported via the bus.

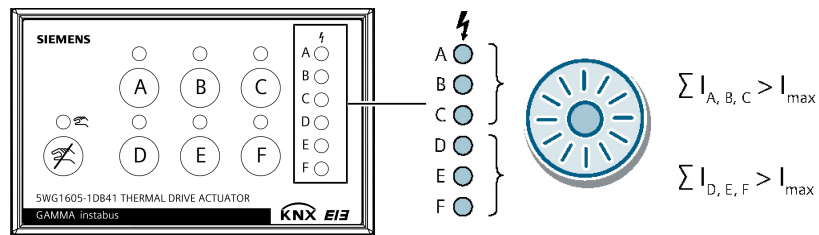
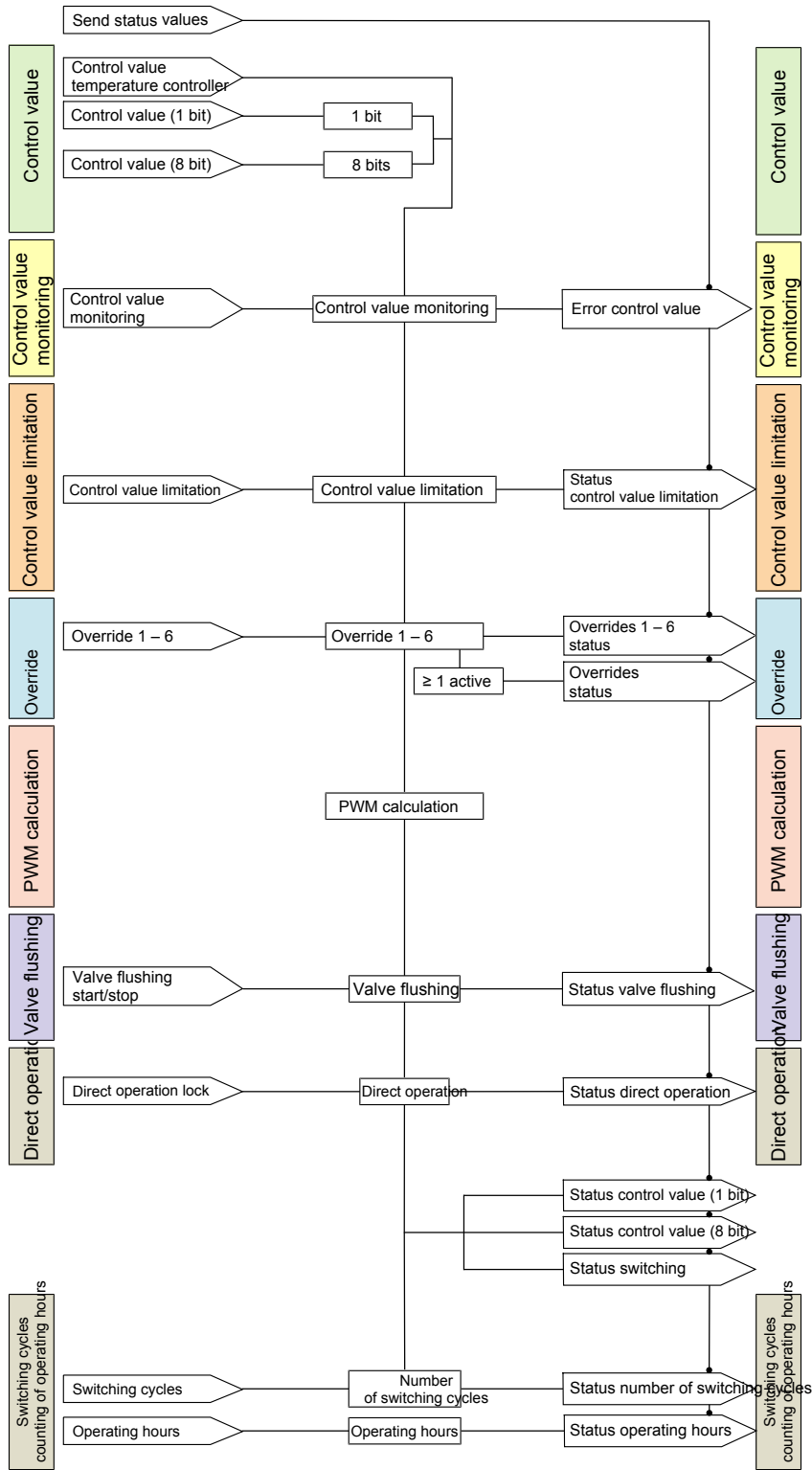

Fig. 6: Error display for overload on the channel groups

Description

- The error LEDs of the affected channel groups A/B/C and/or D/E/F light up permanently.

Schematic design of a thermal drive actuator channel



Position and function of the connections and labeling

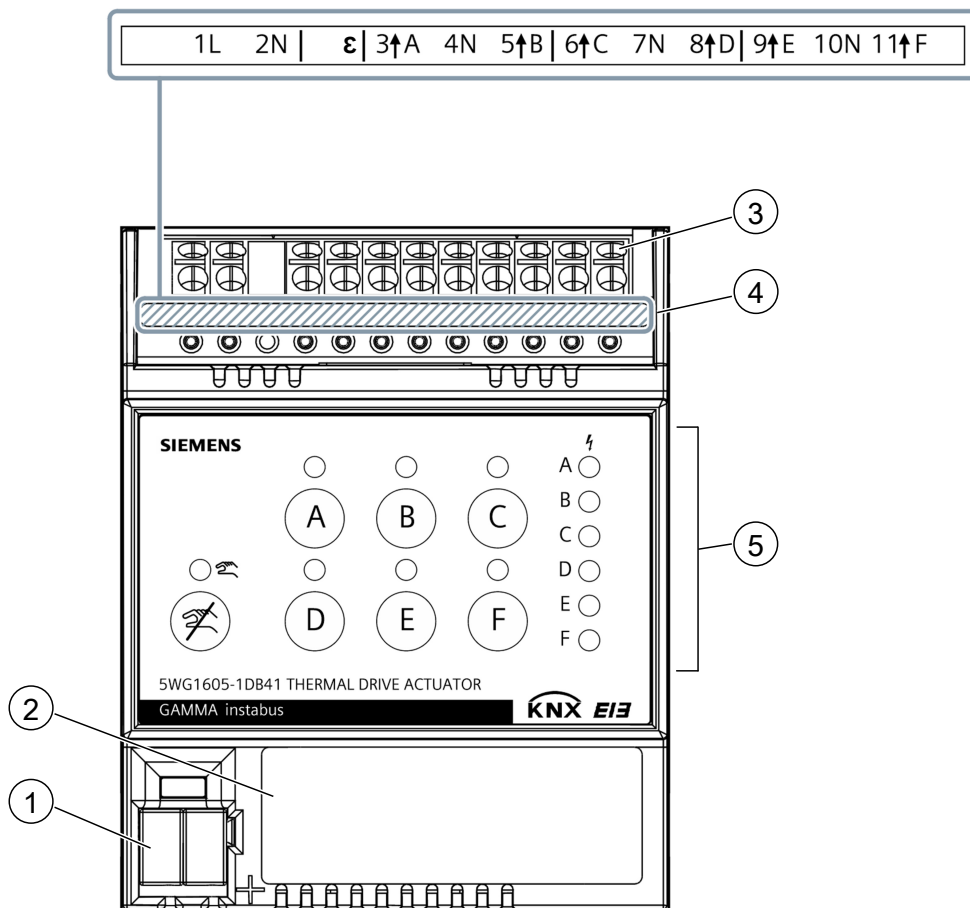

Fig. 7: Position and function of the connections and labeling, Thermal Drive Actuator N 605D41, 6 x AC 24...230 V

Pos.	Element	Function
1	Connection pins for KNX bus terminal block, screwless	Connect the KNX bus.
2	Label field	Enter the physical address.
3	Connection terminals	Connect input and loads.
4	Labeling of the control outputs	
5	Membrane keypad with LEDs	Execute direct operation. Open and close valve. Display status, diagnostic routine and error messages.

Position and function of the operating and display elements

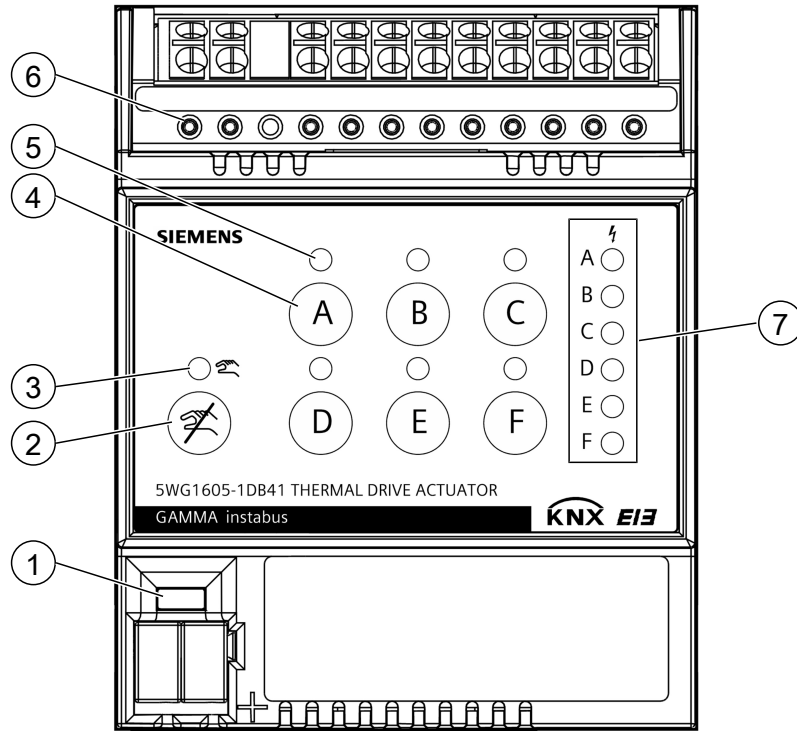



Fig. 8: Operating and display elements, Thermal Drive Actuator N 605D41, 6 x AC 24...230 V

Pos.	Operating or display element	Function
1	Programming LED (red), Programming button	<p>Short push of button (< 2 s):</p> <ul style="list-style-type: none"> Activate programming mode, display status (LED on = active). <p>Very long push of button (> 20 s):</p> <ul style="list-style-type: none"> Reset to factory settings (after 20 s, the LED starts flashing for about 8 s).
2	Button: Deactivate direct operation	<p>Short push of the button:</p> <ul style="list-style-type: none"> Deactivate direct operation for all channels. <p>Hold down the key and briefly press the "Open/close valve" key of a channel (4):</p> <ul style="list-style-type: none"> Deactivate the direct operation of the respective channel.
3	Status LED of direct operation (yellow)	LED flashes if direct operation is active for at least one channel.
4	Button: Open/close valve of a channel	<p>Short push of the button (< 5 s):</p> <ul style="list-style-type: none"> Open/close valve. Activate direct operation for the channel. <p>The "Open" or "Close" function is executed according to the configuration of the valve control direction. In the factory settings, the setting "Valve in de-energized state: Closed" is active.</p> <p>Long push of the button of channel A, B or C (> 5 s):</p> <ul style="list-style-type: none"> Start diagnostic routine for error detection for channel group A/B/C. <p>Long push of the button of channel D, E or F (> 5 s):</p> <ul style="list-style-type: none"> Start diagnostic routine for error detection for channel group D/E/F.

Pos.	Operating or display element	Function
5	Status LED of a channel (red)	<p>Indicates the status of the respective channel.</p> <p>Bus operation:</p> <ul style="list-style-type: none"> ● 2-point controller/2-point operation: <ul style="list-style-type: none"> – LED ON: Valve is opened under consideration of the valve control direction. – LED OFF: Valve is closed under consideration of the valve control direction. ● PWM mode: <ul style="list-style-type: none"> – LED ON: Control value 100%, valve is opened under consideration of the valve control direction. – LED OFF: Control value 0%, valve is closed under consideration of the valve control direction. – The LED flashes asymmetrically with a period duration of approx. 5 sec. and thus maps the control value. Example: LED 0.5 s ON, 4.5 s OFF: Control value 10 % LED 2.0 s ON, 3.0 s OFF: Control value 40 % LED 3.5 s ON, 1.5 s OFF: Control value 70 % LED 4.5 s ON, 0.5 s OFF: Control value 90 % <p>Direct operation:</p> <ul style="list-style-type: none"> ● LED flashes alternately with the status LED for direct operation: Valve is opened under consideration of the valve control direction. ● LED flashes simultaneously to the status LED for direct operation: Valve is closed under consideration of the valve control direction.
6	Test contacts	Metering point for voltage testing
7	Error LEDs	Indicate the error detection status (Display/operating elements and error displays on the device. [▶ 6]).

Type overview

Type	Description	Item number	KNX PL-Link
 N 605D41	Thermal Drive Actuator N 605D41, 6 x AC 24...230 V	5WG1605-1DB41	yes

Version of the Engineering Tool Software

Application	Version
Engineering Tool Software (ETS)	ETS 5 or above

Product documentation and support

Product documentation

Documents related the product, such as operating and installation instructions, application program description, product database, additional software and CE declarations can be downloaded from the following website:

<http://www.siemens.com/gamma-td>



Frequently asked questions

For frequently asked questions about the product and their solutions, see:

<https://support.industry.siemens.com/cs/products?dtp=Faq&mf=ps&lc=de-WW>



Support

Contact details for additional questions relating to the product:

Tel.: +49 89 9221-8000

<http://www.siemens.com/supportrequest>



Security

⚠ CAUTION**National safety regulations**

Failure to comply with national safety regulations may result in personal injury and property damage.

- Observe national provisions and comply with the appropriate safety regulations.

⚠ WARNING**Risk of death due to electric voltage and electric current!**

Electrical expertise is required for the installation. Incorrect installation can deactivate electrical safety features without this being apparent to a lay person.

- Do not open the casing of the device.
- The device should only be installed and put into operation by a certified electrician.
- Overload/short-circuit faults may only be rectified by qualified electricians and with the AC voltage switched off.
- Secure each phase with a B16 line protection switch.
- Only use conventional transformers that comply with the relevant standards and contain a thermal fuse.

⚠ WARNING**Danger due to electrical voltage**

The device is not suitable for unlocking.

Voltage may be present at the outputs even when the device is switched off. When working on the connected consumers, always disconnect the device from the power supply via the upstream fuse.

NOTICE**Behavior in the event of a fault**

- ▷ Actuators of a channel output or a group do not switch.
- Identify the cause of the overload shutdown using the error LEDs on the front of the device.
- Switch off the power supply.
- Resolve short circuit/overload and replace defective actuators.
- Check and, if appropriate, reduce the number of connected actuators.
- Switch on the power supply of the device again.

Connecting thermal actuators to the semiconductor outputs

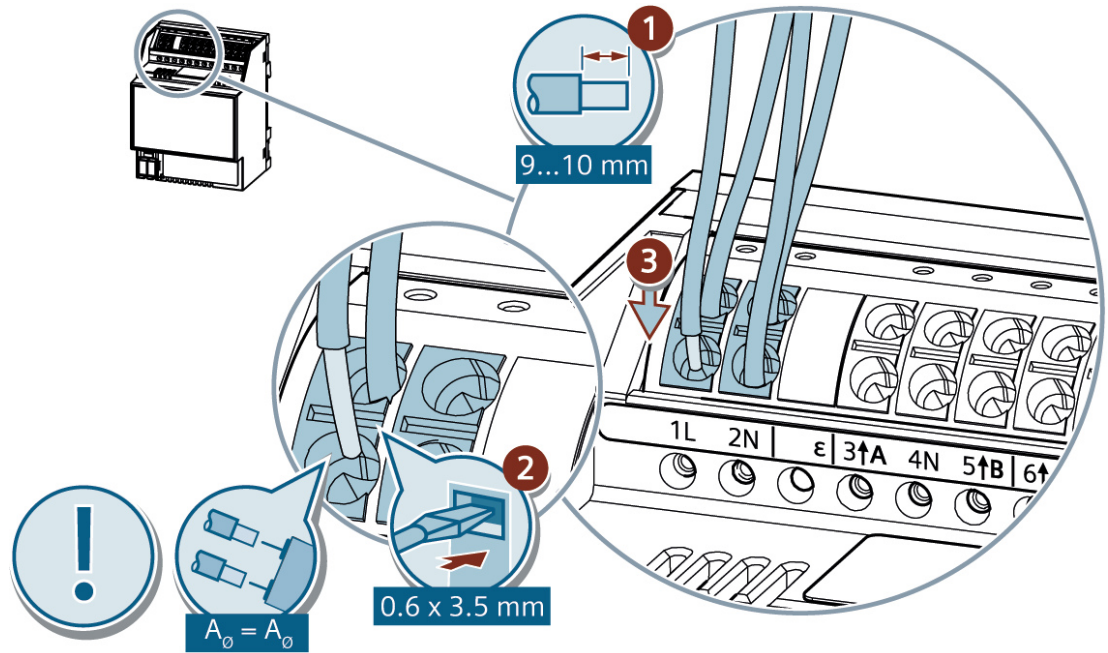
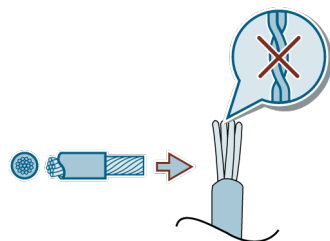

Fig. 9: Thermal Drive Actuator N 605D41, 6 x AC 24...230 V

Cu	
	0.5...2.5 mm ²
	2.5 mm ²



Connecting KNX

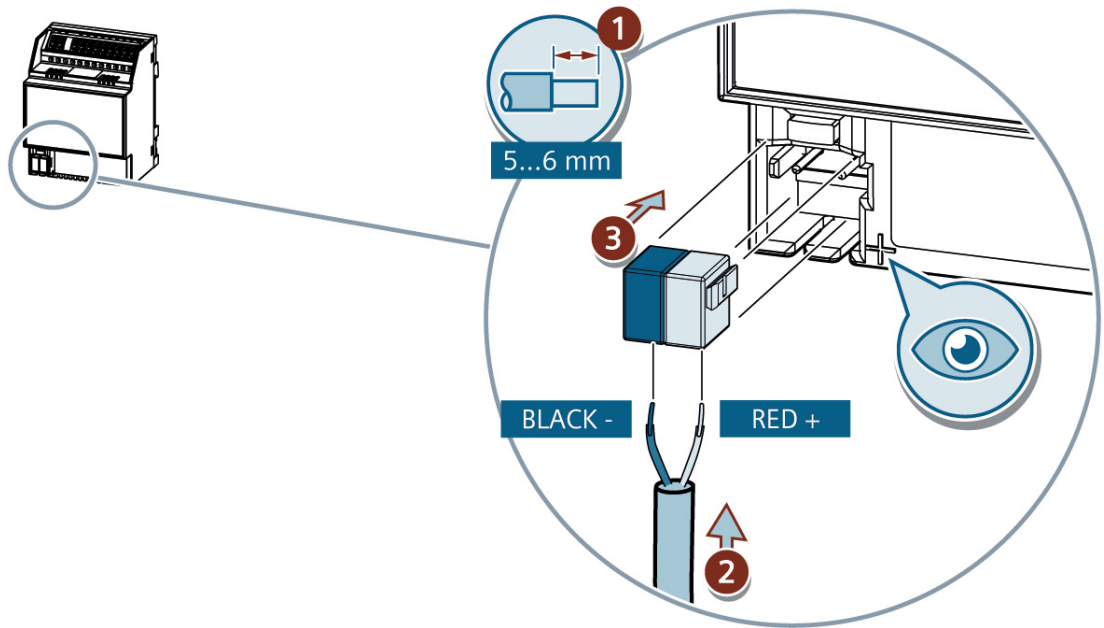

Fig. 10: Thermal Drive Actuator N 605D41, 6 x AC 24...230 V

Cu	
	0.6...0.8 mm

Testing KNX 24 V DC type. SELV

This test can be used to check whether the bus connection cable is connected with the correct polarity and whether device is supplied with bus voltage.

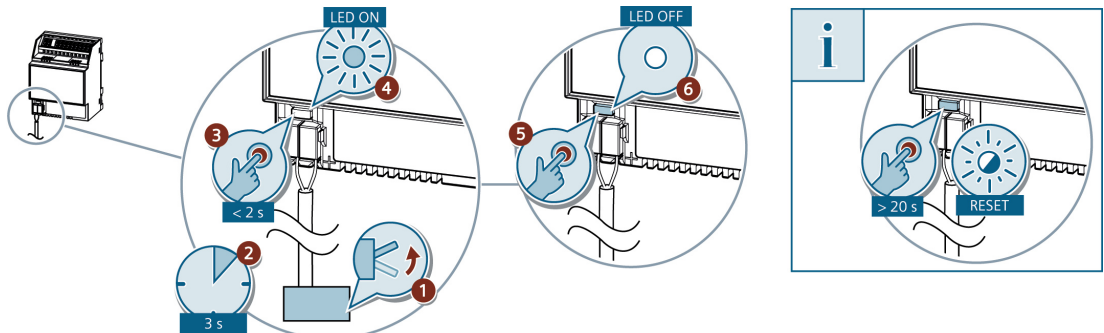

Fig. 11: Thermal Drive Actuator N 605D41, 6 x AC 24...230 V

A very long push of the programming button of more than 20 seconds resets the device to its factory settings.

Status display in bus operation (A|B|C|D|E|F Un~24...230 V)

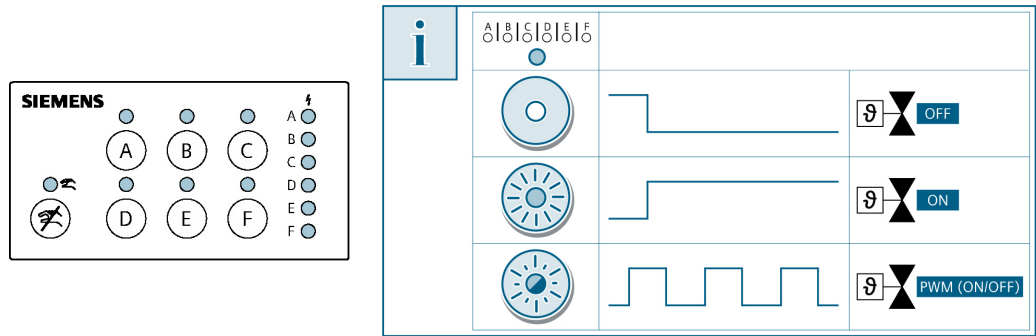

Fig. 12: Thermal Drive Actuator N 605D41, 6 x AC 24...230 V

For pulse width modulation (PWM), the flashing of the status LED represents the control of the output. The period duration is 5 s fixed.

Function test of the installation

This test can be used to check whether the thermal actuators have been connected correctly.

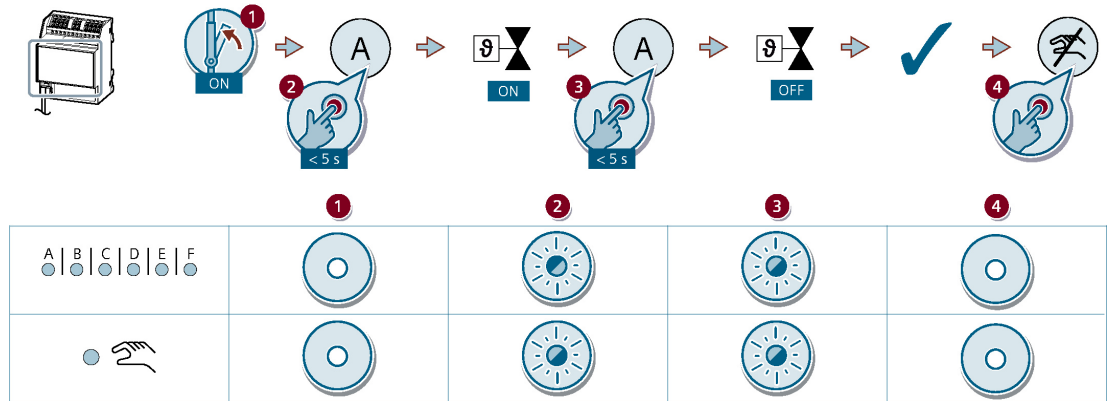

Fig. 13: Thermal Drive Actuator N 605D41, 6 x AC 24...230 V

Disposal

	<p>The device is considered an electronic device for disposal in accordance with European Directive and may not be disposed of as domestic waste.</p> <ul style="list-style-type: none"> • Use only designated channels for disposing the devices. • Comply with all local and currently applicable laws and regulations.
--	---



If a device is defective, contact the local sales office.

Power supply	
KNX bus voltage	DC 24 V (DC 21...30 V)
KNX power consumption	15 mA
KNX power loss (power consumption)	0.36 W

Outputs (semiconductor switch)	
Number of outputs	6
Switching voltage	AC 24V... 230V (50 - 60 Hz)
Output current	
Rated current per channel* ¹	0.5 A
max. inrush current (2 s)* ¹	3.5 A
max. inrush current (2 min)* ¹	0.9 A

Actuators	
Number of actuators per channel or group 24 V	3* ²
Number of actuators per channel or group 230 V	6* ³

*¹ per channel and group of 3 outputs

*² for e.g. max. 300 mA for max. 2 min

*³ for e.g. max. 580 mA for max. 2 s

Power loss	
Maximum power loss of the device at rated output	2.1 W

Mechanical data	
Housing material	Plastic
Dimensions	Rail-mounted device in N dimension, width 4 HP (1 HP = 18 mm) See Dimensions [► 20]
Product weight	145 g
Fire load	4 MJ

Environmental conditions	
Ambient temperature in operation	-5 °C...+45 °C (23 °F...113 °F)
Storage temperature	-20 °C...+70 °C (-4 °F...158 °F)
Transport temperature	-25 °C...+70 °C (-13 °F...158 °F)
Relative humidity (non-condensing)	5 %...95 %
Environmental rating	EN 60721-3-3 class 3k5

Protection settings	
Degree of pollution (according to IEC 60664-1)	2
Over-voltage category (according to IEC 60664-1)	III

Protection settings	
Housing protection class (according to EN 60529)	IP20
Electrical safety, bus (SELV)	yes
Electrical safety, device fulfills	EN 50428
EMC requirements, device complies with	EN 50428
Test mark	KNX, EAC, RCM, WEEE, China-RoHS
CE mark	yes

Reliability	
Failure rate (at 40°C)	471 fit

Connection example

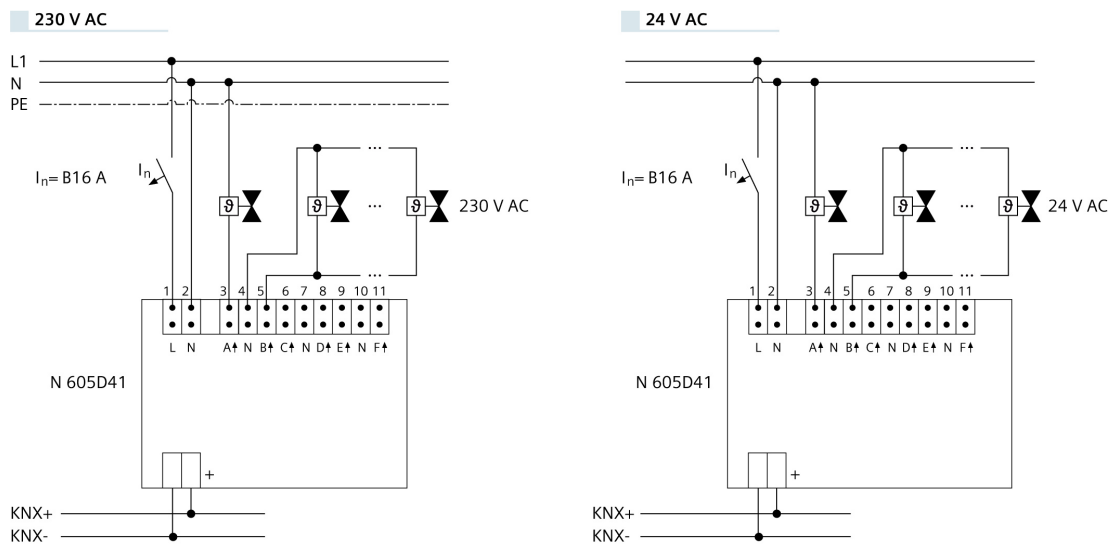

Fig. 14: Thermal Drive Actuator N 605D41, 6 x AC 24...230 V

⚠ CAUTION



A common supply voltage for all channels is applied to terminals L1 and N.
 Two output channels share a central ground terminal.
 The neutral conductors of the actuators can be connected either directly to the ground terminal on the device or alternatively together via a suitable ground potential.
 The neutral conductors of the outputs may only be used for connecting the electro-thermal actuators.

Dimensions

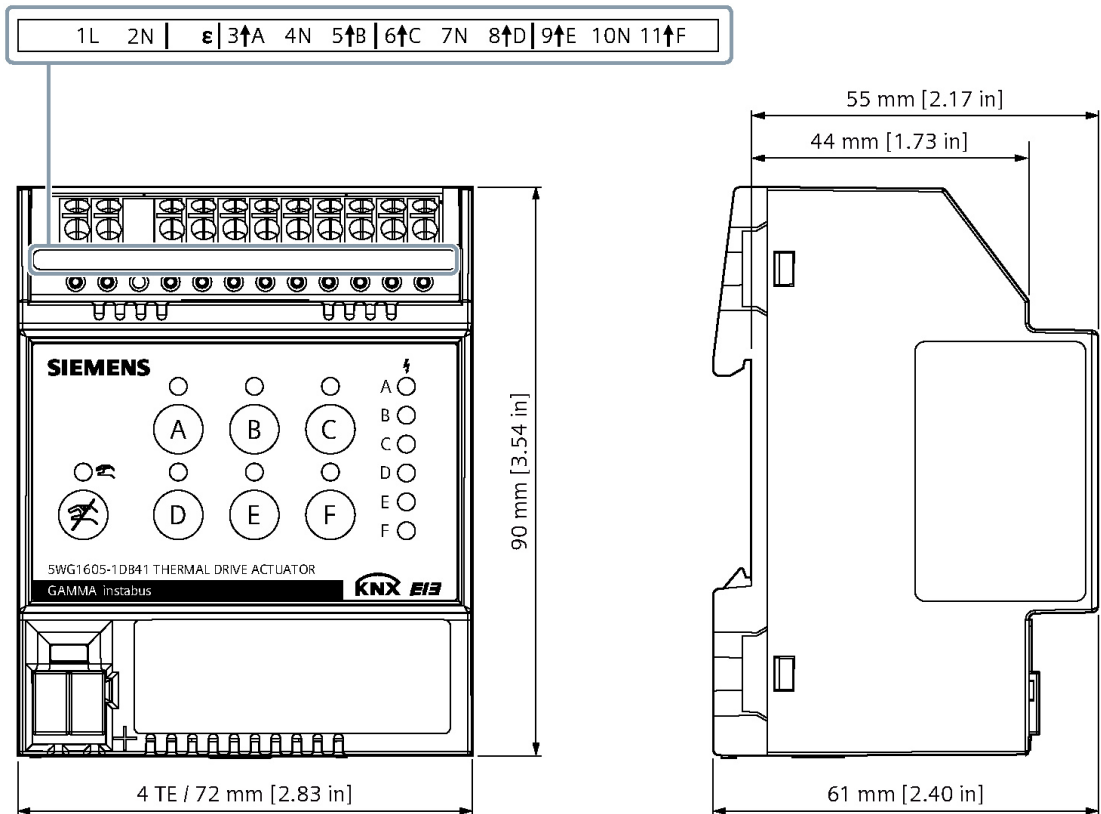

Fig. 15: Thermal Drive Actuator N 605D41, 6 x AC 24...230 V

Compliance information

FCC Statement

⚠ WARNING



Installation and usage of equipment not in accordance with instructions manual may result in:

Radiation of radio frequency energy
Interference to radio communications

- Install and use equipment in accordance with installation instructions manual
- Read the following information

This equipment generates, uses, and can radiate radio frequency energy and if not installed and used in accordance with the instructions manual, may cause interference to radio communications.

It has been tested and found to comply with the limits for a Class A computing device pursuant to Part 15 of FCC Rules, which are designed to provide reasonable protection against such interference when operated in a commercial environment.

Operation of this equipment in a residential area is likely to cause interference in which case the user at his own expense will be required to take whatever measures may be required to correct the interference.

FCC Statement

This equipment has been tested and found to comply with the limits for a Class B digital device, pursuant to part 15 of the FCC Rules. These limits are designed to provide reasonable protection against harmful interference in a residential installation. This equipment generates, uses and can radiate radio frequency energy and, if not installed and used in accordance with the instructions, may cause harmful interference to radio communications. However, there is no guarantee that interference will not occur in a particular installation. If this

equipment does cause harmful interference to radio or television reception, which can be determined by turning the equipment off and on, the user is encouraged to try to correct the interference by one or more of the following measures:

- Reorient or relocate the receiving antenna.
- Increase the separation between the equipment and receiver.
- Connect the equipment into an outlet on a circuit different from that to which the receiver is connected.
- Consult the dealer or an experienced radio/TV technician for help.

This device complies with Part 15 of the FCC rules. Operation is subject to the following two conditions:

1. This device may not cause harmful interference, and
2. this device must accept any interference received, including interference that may cause undesired operation

FCC Caution: Changes or modifications not expressly approved by Siemens Switzerland Ltd. could void the user's authority to operate the equipment. United States representative <https://new.siemens.com/us/en/products/buildingtechnologies/home.html>

Industry Canada statement

This device complies with ISED's license-exempt RSSs. Operation is subject to the following two conditions:

1. This device may not cause interference, and
2. This device must accept any interference received, including interference that may cause undesired operation.

Issued by
Siemens Switzerland Ltd
Smart Infrastructure
Global Headquarters
Theilerstrasse 1a
CH-6300 Zug
+41 58 724 2424
www.siemens.com/buildingtechnologies

© Siemens Switzerland Ltd, 2023
Technical specifications and availability subject to change without notice.

Document ID A6V13488290_en--_b
Edition 2023-04-06